

No More Overtime
No More Tapeout Delays

SKILLCAD

Accelerating Custom IC Layout

SKILLCAD Inc. is dedicated to productivity enhancement tools for custom IC layout design, providing optimized by construction solutions to achieve better layout quality and shorter time-to-market.

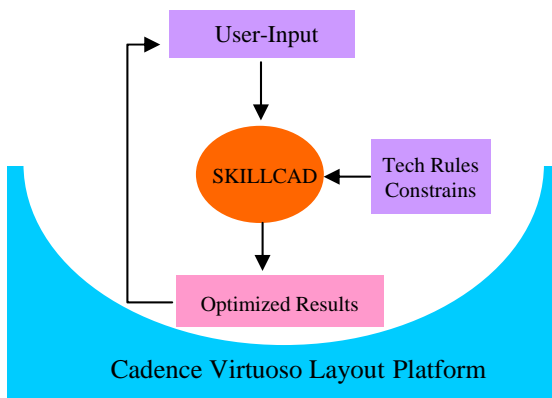

SKILLCAD Tools run directly in Cadence Layout Platform, supporting both OA (IC6.1) and CDBA (IC5.1) database.

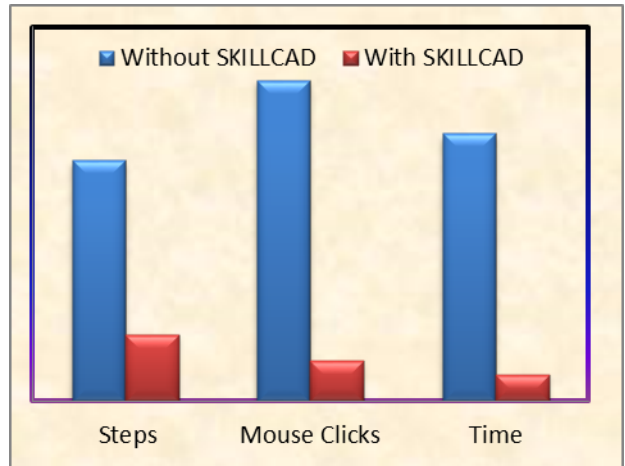

IC Layout Automation Suite provides 70+ advanced utilities to expedite routinely layout, including bus routing, bus editing, via dropping, guardring, pin/label creating/placement, aligning, slotting, dummy pattern filling, net extraction, shielding...

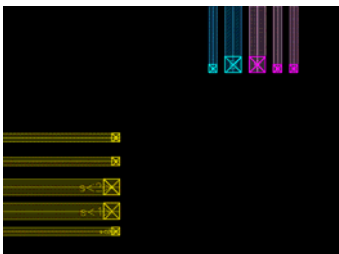

Bus Connect
By Net Name

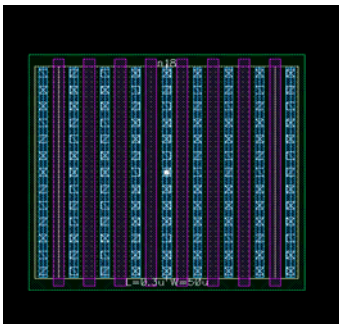
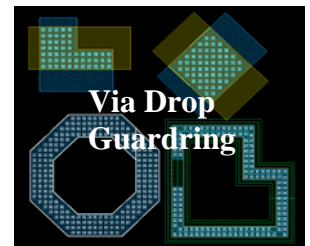
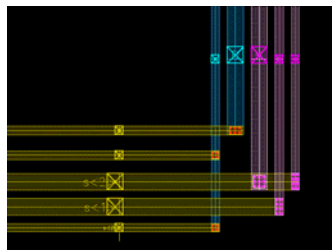

Gate Cont
ViaChain

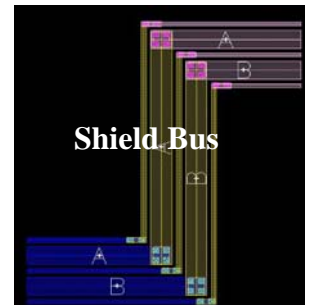
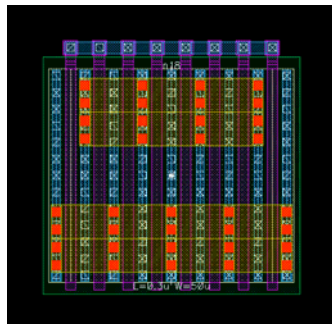

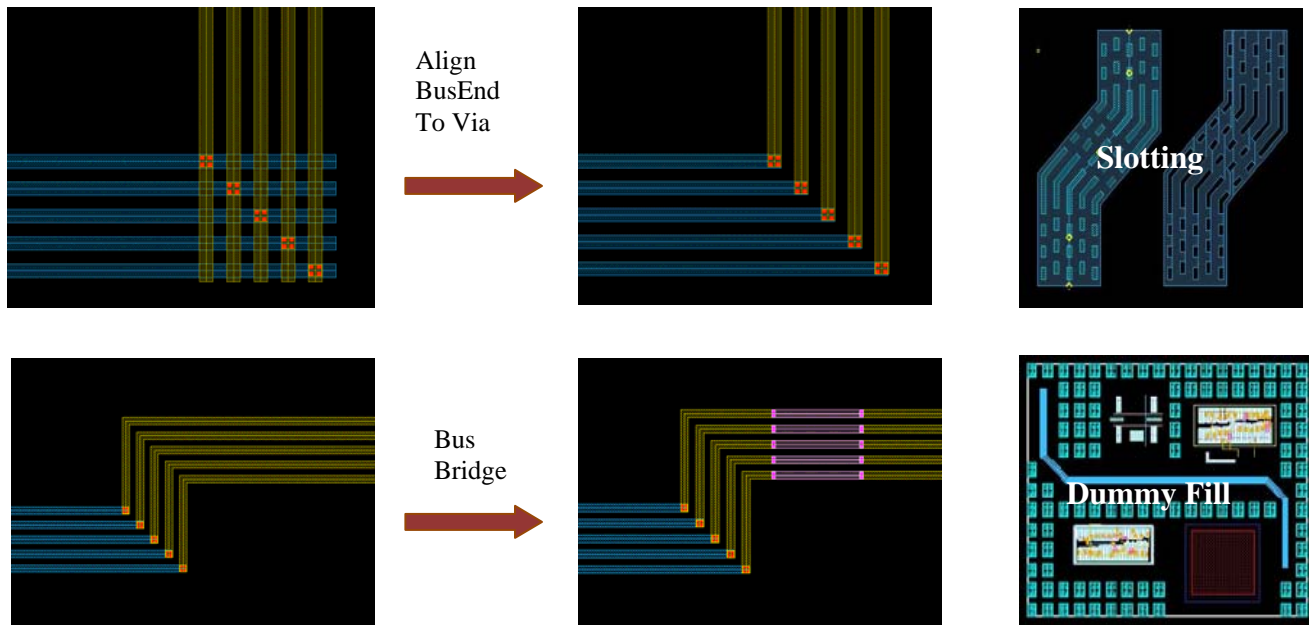

NanoTrack Layout Editor is for an advanced layout methodology which requires wires on certain routing track patterns and a particular via configuration according to wire width and direction.

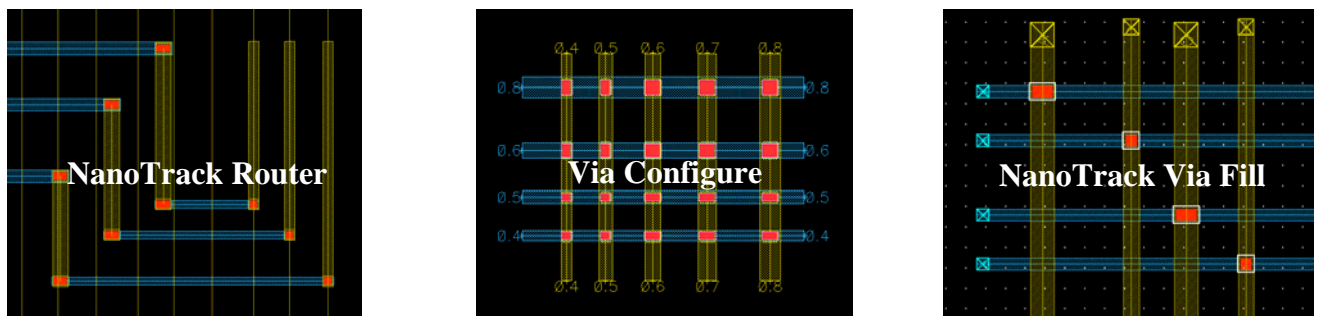

Flat Panel Layout Editor provides the first full solution for TFT-LCD/Touch screen layout design in Virtuoso Platform. In addition to a bunch of specific utilities, it can handle thousands of connections at the same time with constraint of resistance, spacing, wiggle patterns etc.

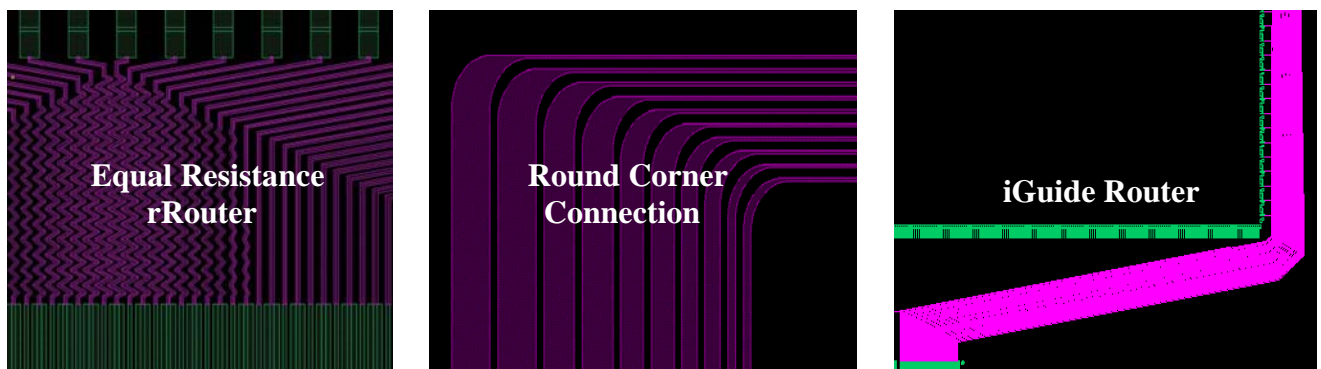

Visit WWW.SKILLCAD.COM for more information.